







ST 010 201 0705



- 200mm projection
- fixed spout
- rectangular spray pattern with 40 individual jets
- hole diameter valve 35 mm
- hole diameter spout 40 mm
- rosette 60 x 60 mm
- max. flow 4.5 l/min
- lead-free
- This product can help a building meet the requirements of Green Building Rating Systems, e.g. LEED®, BREEAM®, DGNB

	Brushed Platinum	ST 010 201 0705-06
	Chrome	ST 010 201 0705-00
	Dark Chrome	ST 010 201 0705-19
	Brushed Champagne (22kt Gold)	ST 010 201 0705-46
	Champagne (22kt Gold)	ST 010 201 0705-47
	Brushed Dark Platinum	ST 010 201 0705-99

Individual components of this set



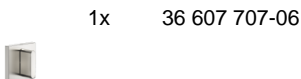
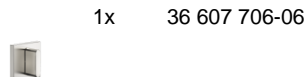



You need the following components for this set



ST 010 201 0705



- 200mm projection
- fixed spout
- rectangular spray pattern with 40 individual jets
- hole diameter 37 mm
- lead-free
- 1/2" connection
- plug-link mounting
- max. flow 4.5 l/min
- This product can help a building meet the requirements of Green Building Rating Systems, e.g. LEED®, BREEAM®, DGNB

	Brushed Platinum	13 800 705-06
	Chrome	13 800 705-00
	Dark Chrome	13 800 705-19
	Brushed Champagne (22kt Gold)	13 800 705-46
	Champagne (22kt Gold)	13 800 705-47
	Brushed Dark Platinum	13 800 705-99

Required miscellaneous

Concealed adapter -

35 080 970-90
0010



ST 010 201 0705

mm [inches]

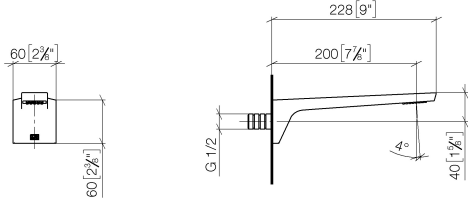

Flow rate chart

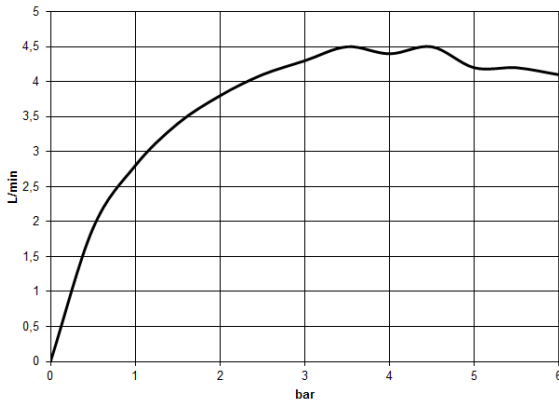

Codes & Standards

ASME
A112.18.1/CSA
B125.1

California Energy
Commission
(CEC)

NSF/ANSI 372

NSF/ANSI/CAN
61

Water Sense



Certificates

LGA_28685.

IAPMO_N-4976.

IAPMO_8834 (1).

IAPMO_4976 (6).

WRAS_1512013.

IAPMO_6397.

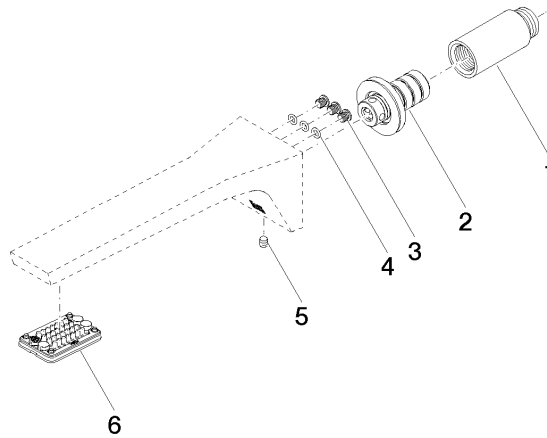

Spare parts list

No.	Item Number	Name	Quantity used	Delivery time
1	09 24 03 081 10 90	extension	1	2
2	90 24 03 108 01 90	nipple set	1	2
3	09 30 30 113 20 90	screw	3	2
4	09 14 10 001 90	seal	3	2
5	90 31 11 004 00 90	pin	1	2
6	90 11 02 297 00 90	aerator	1	2







CL.1 Wall-mounted basin mixer without pop-up waste - Brushed Platinum

CL.1

ST 010 201 0705



- rosette 60 x 60 mm
- with cold marking
- head part with cut-to-length spindle and sleeve

	Brushed Platinum	36 607 706-06
	Chrome	36 607 706-00
	Dark Chrome	36 607 706-19
	Brushed Champagne (22kt Gold)	36 607 706-46
	Champagne (22kt Gold)	36 607 706-47
	Brushed Dark Platinum	36 607 706-99

Required miscellaneous

	Wall valve 1/2" - •max. recess depth 150 mm •min. recess depth 105 mm	35 607 970-90 0010
---	--	-----------------------



CL.1 Wall-mounted basin mixer without pop-up waste - Brushed Platinum

CL.1

ST 010 201 0705

ST 010 201 0705

mm [inches]



Codes & Standards

ADA	ASME A112.18.1/CSA B125.1
-----	---------------------------------

Certificates

DVGW_DW- 6501DN0116.	IAPMO_4976 (1).	LGA_29931.	WRAS_2010066.	LGA_29932.
-------------------------	-----------------	------------	---------------	------------

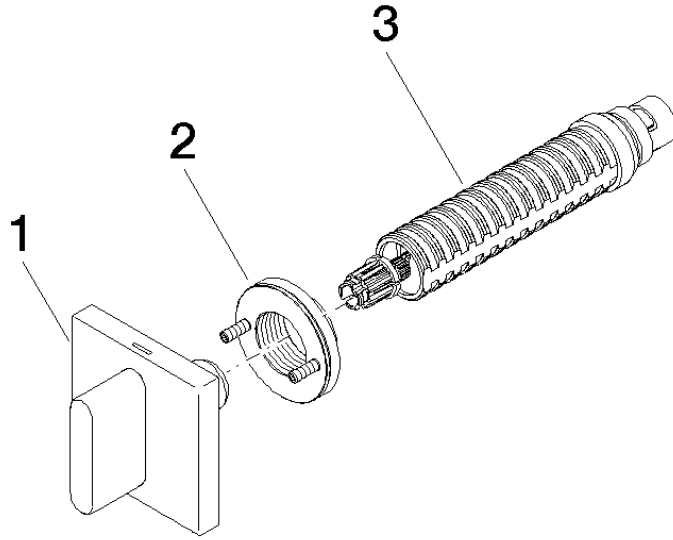

Spare parts list

No.	Item Number	Name	Quantity used	Delivery time
1	90 20 70 051 02-06	handle (cold)	1	10
2	90 21 02 108 00 90	disc	1	2
3	90 90 03 143 00 90	top	1	2







CL.1 Wall-mounted basin mixer without pop-up waste - Brushed Platinum

CL.1

ST 010 201 0705



- rosette 60 x 60 mm
- with hot marking
- head part with cut-to-length spindle and sleeve

	Brushed Platinum	36 607 707-06
	Chrome	36 607 707-00
	Dark Chrome	36 607 707-19
	Brushed Champagne (22kt Gold)	36 607 707-46
	Champagne (22kt Gold)	36 607 707-47
	Brushed Dark Platinum	36 607 707-99

Required miscellaneous

	Wall valve 1/2" - ●max. recess depth 150 mm ●min. recess depth 105 mm	35 607 970-90 0010
---	--	-----------------------



CL.1 Wall-mounted basin mixer without pop-up waste - Brushed Platinum

CL.1

ST 010 201 0705

ST 010 201 0705

mm [inches]

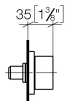
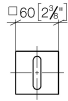

Codes & Standards

ADA	ASME A112.18.1/CSA B125.1
-----	---------------------------------

Certificates

DVGW_DW- 6501DN0116.	IAPMO_4976 (1).	LGA_29931.	WRAS_2010066.	LGA_29932.
-------------------------	-----------------	------------	---------------	------------

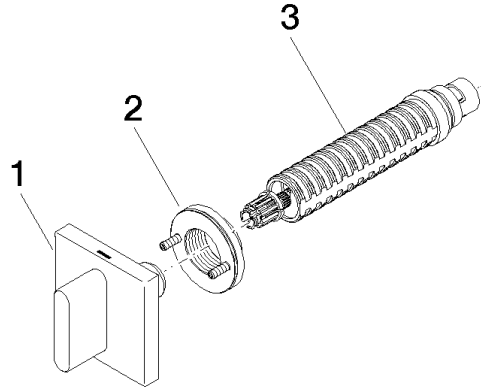

Spare parts list

No.	Item Number	Name	Quantity used	Delivery time
1	90 20 70 051 03-06	handle (hot)	1	10
2	90 21 02 108 00 90	disc	1	2
3	90 90 03 142 00 90	top	1	2